

*Lennart Pettersson (LP), axe-smith
at Gränsfors Bruks Axe Forge*



AN AXE BECOMES AS GOOD AS ITS SMITH

Gränsfors Axes are forged by very professional smiths. The proof of this professionalism is that they are able to forge axes with such precision that no supplementary work, to hide mistakes in the forging, is needed.

At Gränsfors Bruks the forging craft is allowed to take its time. The smiths do not work by the piece. They take care and do the right forging from the beginning. There is no need to stone or grind or smooth or paint the axes in order to hide or eliminate imperfections in the forging.

A smith at Gränsfors Bruks has nothing to hide and he is proud of his professional standards. When he is satisfied with his work and has accepted his axe, he marks the head with his initials beside the company's crown label:

LP Lennart Pettersson

UN Ulrik Nilsson

CK Claudia Kowalek

LE Lars Enander

BA Bert-Ove Andersson

US Ulrika Stridsberg

KS Kjell-Åke Sjölund

RA Rune Andersson

MM Mattias Mattsson

DG Daniel Gräntz

JE Joakim Eriksson

In 1990 Gränsfors Bruks' Axes were awarded a prize in "Ecological Design" from The Swedish Society for Nature Conservation in cooperation with The Swedish Society of Crafts and Design. In 1995 Gränsfors Bruks received another award from The Swedish Society of Crafts and Design for the "Hunter's Axe".



AWARDED FOR
EXCELLENT SWEDISH DESIGN
1995

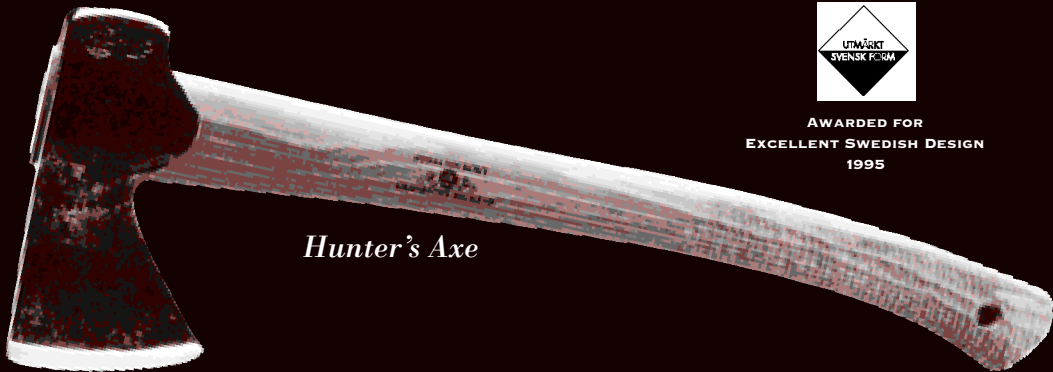

Hunter's Axe



Carpenter's Axe

Forging is important, but at the same time everything else must also be made in the right way. Gränsfors Axes are forged from a Special Swedish Steel for axes and the blades are tempered and annealed to the right toughness. The handles are made of first quality hickory and the axeheads are oiled and provided with a grain-leather sheath. All steps in the axe production are carefully tested.



THOUGHTS BEHIND THE AXES FORGED TODAY AT GRÄNSFORS BRUKS

Before industrialism, axes were forged at many small smith's shops. The form and structure of the axes were decided by the function of the axe, the demands of the user and the craftsmanship of the smith. Up until the middle of the 19th century axes were used in small-scale activities, the self-subsistent peasant society.

With the booming forest industry and professional logging in the 19th century, there came entirely new and bigger clients for axes: specialized forest workers and forestry companies. The increased demand for axes made the commercial interest in the axe business increase and the production was concentrated to big axe factories. Mass production and rationalizations of the production lowered the production costs. Little by little the form and structure of axes changed, often at the expense of quality. Axes became standardized mass produced industry products. Great amounts of energy were used

in order to make the axes conform to the current demands on an industry product: every axe of a certain model should look exactly alike.

In order to hide the structure of the axe head forged by hand, the surface of the forging was stoned, ground, buffed, painted, japanned and stove varnished. Colourful brand labels became a must.

In a certain way we are back at the time before the entry of the booming forest industry. There are no axe-using forest workers any longer. The millions of cubic feet of pulpwood and timber that arrive today at forest industries have never been grazed by an axe. Chain saws, harvesters and logging machines have taken over completely. Today most axes are used in small-scale activities by people like homeowners, firewood cutters, campers, hunters, joiners, woodworkers, log builders.



In cooperation between the smiths at Gränsfors Bruks and the skilled craftsman designer Hans Erik Persson, in 1989 Gränsfors axes were re-developed into tools for specific purposes. It was a step backwards, towards a more traditional production method based on craftsmanship. The form and function of the axes, as well as the forging and production technique, emanate from old, often forgotten knowledge.

The axes and the production of axes at Gränsfors Bruks today are based on the following five fundamental theses:



1. An axe becomes as good as its smith. There has to be a craftsman behind every single axe.
2. Unnecessary stoning, grinding, epoxy fixing, painting, and other cosmetics are eliminated. This is good for the environment, inside and outside the factory.
3. More sensible production demands less natural resources at the same time as the quality and durability of the axe increases. Also, increased durability will decrease the total consumption of natural resources and decrease waste.
4. We have an unlimited responsibility for Total Quality. Working conditions, product quality and concern for nature are some parts of the Total; humanity and ethics are as important.
5. High level of knowledge of a product will increase its value. Therefore information about axes is important. The AXE-BOOK is one way, the Axe Museum is another. The AXE-BOOK is an integrated part of the axe.

Gabriel Brånby



PARTS OF THE AXE

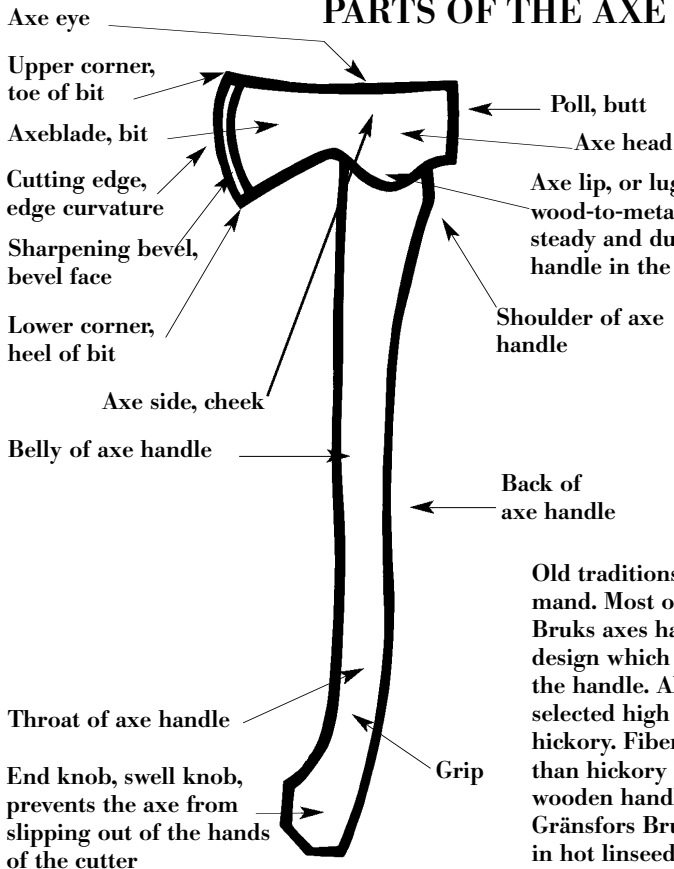

Gränsfors Bruks axes come with Grain-Leather Sheath

Old traditions are adapted to today's demand. Most of the handles of Gränsfors Bruks axes have a unique ergonomic design which gives a steady grip around the handle. All handles are made of selected high quality (prima) American hickory. Fiberglass handles are stronger than hickory handles but we believe that wooden handles are more ecological. Gränsfors Bruks axe handles are soaked in hot linseed oil and dripped dry. They are then covered with beeswax to help keep the dirt off.

WHICH AXE SHOULD I CHOOSE?



Wildlife Hatchet

A small, light axe which can be easily carried, masked with its leather sheath, inside your pack or on your belt. Even with a small axe you can manage a lot: cut branches in the back-yard or chop and split sticks for a camp fire. This little hatchet awakes in many of us memories and dreams of exciting camps and adventures. The hatchet has a 3" face and a 13 1/2" hickory handle and the head weighs 1 lb. It comes with a grain-leather sheath.



Hunter's Axe

Specially made for hunters. The poll is forged thinner than normal and gently rounded and burnished to a **Flay Poll** to be used when skinning an animal. You pull the hide with one hand at the same time you hit with the Flay Poll of the axe between the hide and the flesh; and stroke by stroke the hide comes off. The axe is good for chopping, in wood as well as meat. The grip of the handle has circular grooves which gives a steady grip even if your hands are wet or sticky. This axe has received, as the first and only axe in Sweden, a design award from The Swedish Society of Crafts and Design. The axe has a 3 1/4" face and a 19" hickory handle and the head weighs 1 1/2 lb. It comes with a grain-leather sheath.

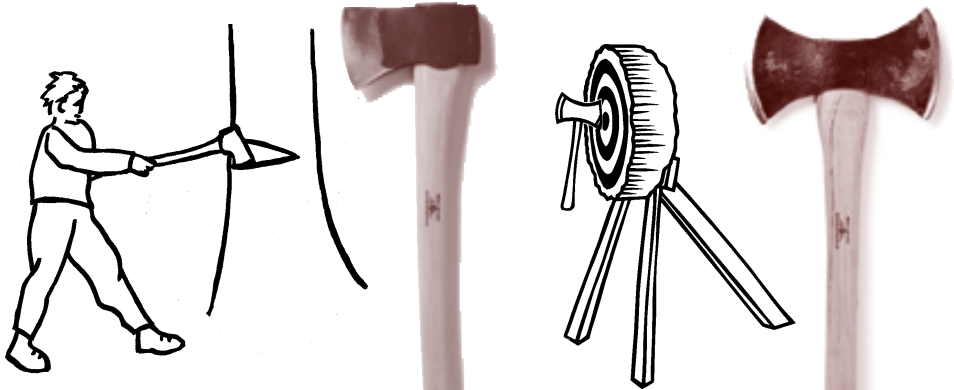

American Felling Axe

A professional axe for working in the same way as the “fallers” of the old days. Hand forged out of a solid piece of steel and carefully tempered and sharpened. This traditional American single-bit axe was asked for by Geoffrey Burke, boat-builder and axe man in New Hampshire. He and an axe collector, Lawrence Lyford, put in a lot of effort to help us build the right model. The head weighs 3.3 lb and the face of the bit is 4 1/2”. The axe has an American hickory handle, 31” or 35”. On special orders the handle may be 31” straight. It comes with a grain-leather sheath.

(Yes they had high stumps in the old days).

Double-Bit Axe

Different models of double-bit axes have been popular in the US since the last quarter of the 19th century because of its balanced feel and versatility. Typically, one blade was sharpened to a finely honed, narrow “felling edge”, while the second blade was ground slightly blunter, and used for knots and cutting near the ground where a finely sharpened blade was more likely to be damaged. Today the double-bit axe is used as a **Working Axe** or as a **Throwing Axe** for timber sports. The head weighs 3lb and the face of the bits are about 6”. The Throwing Axe has a 29” straight hickory handle and the Working Axe has a 35” straight hickory handle with swell-knob. They come with two grain-leather sheaths.



Small Forest Axe

Same size as the Hunter's Axe but a more traditional pattern and poll. The blade is thin. The handle is long enough to allow powerful chopping but not too long so it will fit into a rucksack, the back of a car or a boat. Practical for splitting small sticks for the fire or cutting small-diameter limbwood for starter fuel in a fireplace. The axe has a 3 1/4" face and a 19" hickory handle and the head weighs 1 1/2 lb. It comes with a grain-leather sheath.

Scandinavian Forest Axe

A more professional axe for those who want to limb a felled tree in the traditional way. Forged to a thin, curved bit and sharpened to make it suitable for cutting branches in fresh, resinous wood, spruce or pine. The long handle gives extra strength and power to the cut. The axe has a 3 1/2" face and a 25" hickory handle and the head weighs 2 lb. It comes with a grain-leather sheath.



Small Splitting Axe

Can be managed with one hand. Forged and ground to a concave, quite thin blade at the bit. This design helps the axe to go fast into the wood - and then split efficiently when the thicker part hits and pushes apart the wood. **The poll of this axe, like the poll on most axes, is not designed for pounding on a wedge.** The head weighs 2 lb. The face is 2 1/2". The 20" hickory handle has circular grooves at the grip and steel collar near the head. It comes with a grain-leather sheath.



Large Splitting Axe

Designed for splitting chunks of wood, "rounds". The thick part of the concave wedge shaped axe head powers apart the grain of the wood. **The poll is not designed for pounding on a wedge.** The head weighs 3 1/2 lb. The face is 3". The axe has a 27" hickory handle, circular grooves at the grip, steel collar and a grain-leather sheath.

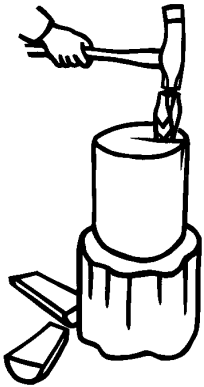

Splitting Maul

Even named Hammer-Poll Axe. Designed for splitting apart large chunks of wood, "rounds". The Maul's head is heavier compared to the Splitting Axes. The poll is designed for pounding on a splitting wedge. The head weighs 5 1/2 lb and has a 2 1/2" face. The hickory handle is 31", has circular grooves at the grip, a steel collar near the head, and comes with a grain leather sheath.

Splitting Wedge

Forged steel wedge. Twisted for maximum splitting. The poll has ground edges. The wedge has a 1 3/4" face, weighs 4 lb and comes with a grain-leather sheath.

**Always wear adequate clothing and protection for your face and eyes.
Please note page 21.**

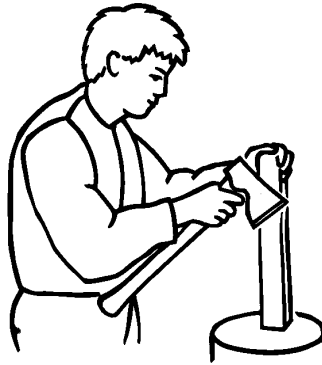

Carpenter's Axe

This axe has a straight edge and thin blade with low angle of the bevel face, suited for work in dry wood. The forged inward curve from the heel to the lip of the head permits your hand to grip almost straight above the center of the edge. This, and the long straight cutting edge, gives rigidity, stability, and control when cutting. Functions like a good heavy knife. The axe poll is ground and can be used as a hammer.

The head weighs 1 1/2 lb and has a 3 1/2" face. The axe has an 18" hickory handle and a grain-leather sheath.





Swedish Carving Axe

A chop axe for heaving bowls and other wooden objects, artistic wood carving and architectural work. The characteristic curved shape of the cutting edge, carried well above the head's eye, the position of the edge in proportion to the handle, the rather thick bit and the big angle of the wide beveled face makes this axe a good carving tool. You "cut on the beveled face" with curved movements. This new axe pattern, based on old Swedish carving techniques, was developed by Wille Sundqvist, master craftsman and author of "*Swedish Carving Techniques*" in cooperation with craftsman adviser Onni Linnanheimo. The handle is "rugged" to give a good grip.

The axe has a 4 1/3" face and a 14" hickory handle and the head weighs 2 lb. It comes with a grain-leather sheath.

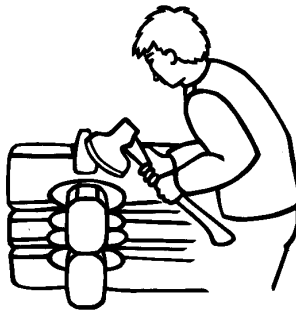

Swedish Broad Axe, model 1900

The pattern of the Broad Axe and the handle is based on old Swedish logging techniques for squaring logs and structural timbers of all kinds.

There is sufficient space between the "blade's beard" and the handle for the user's fingers. Beveled on two sides (double beveled) or on one side, left or right. The eye (and the direction of the handle) may be straight or angled sideways, right or left, to protect the knuckles. One side beveled, left side, normally goes with an eye angled to the right. If you want deeper visible cuts when squaring logs, you can use a broad axe, double beveled, with the blade bent and the eye angled to the right or to the left. The broad axe has a 7" face and a 20" hickory handle and the head weighs 3 lb. It comes with a grain-leather sheath. (Other special tools from Gränsfors Bruks are: Log-House Drawknife, Mortise Axe, Froe, Adze. Ask for information.)





AT GRÄNSFORS BRUKS AXE FORGE



Gränsfors, Nordanstig rural district in Hälsingland, between Hudiksvall and Sundsvall, 4 hours by car, north of Stockholm

Hälsingland is beautiful. That is something one notices when visiting Gränsfors Bruks. Along the winding road between Gnarp and Bergsjö you can see green valleys, lakes and blue mountains. There are red houses and barns scattered among the meadows with grazing horses and sheep. Then a sign catches one's eyes: Gränsfors Bruks. Turning off, nestled between wooden houses and apple trees, there it is, by a turbulent stream. The build-

ing is somewhat bigger than the surrounding cottages and one can see how it has been enlarged throughout the years. Entering the wooden door in the older part of the house, you pass by the warehouse, lunchroom and old-fashioned office

and get down to the forge in the somewhat newer annex. There, big flywheels are moving and a rhythmic throbbing is heard from the forging operation.





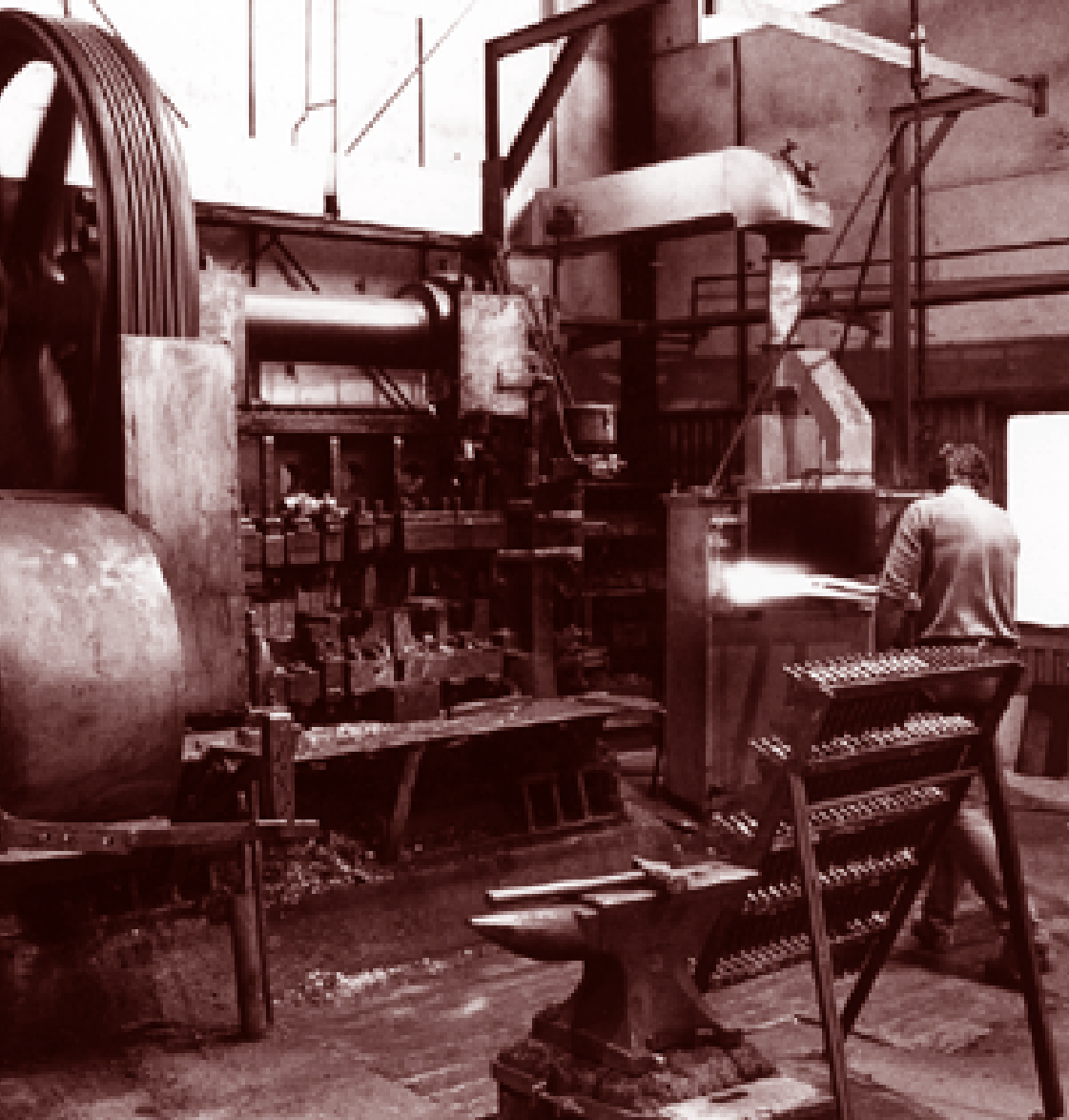

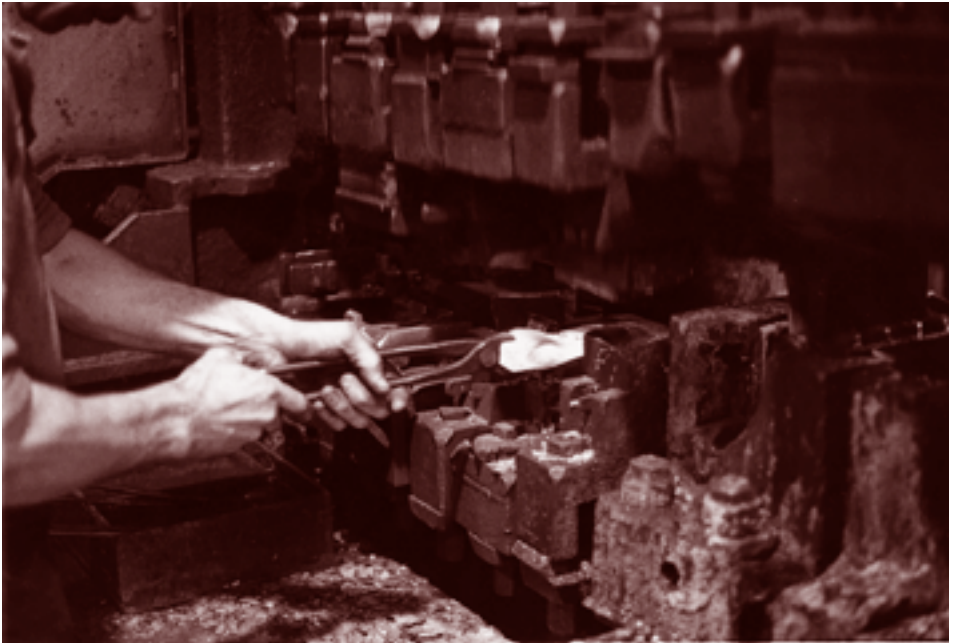

Next to the forging hammers, in ovens that are hotter than 1,200°C, steel bars are heated. When the right temperature is reached, which the smith can see on the red-yellowish color of the steel, a glowing piece is cut off and the treatment in the forging hammers begins. The

smith cleverly handles the hot steel, and slowly the square piece is transformed into an axe head. The smith finishes his work by branding in the Gränsfors Bruks' "label and crown" and his own initials, scrutinizing the axe head and hanging it up to cool.



The room next to the forge is the sharpening room. Here the right edge bevel is established by grinding (beveling) and, after the tempering and annealing operation, the beveled edge is ground with a finer stone, honed and polished.

After the forging and the first step of sharpening the edge, the lower part of the axe head, the blade, is tempered by warming it to 320°C followed by a quick cooling in cold running water. Then the axe head is annealed: kept for 60 minutes in an oven that is 195°C. This relieves the stress in the steel, built up by the forging and tempering processes and gives the bit the desired hardness and toughness. The hardness of the bit is measured, 57 Rockwell C, and every single head is tested by

a smith who, with a big hammer, strikes on the edge's corners. If the blade does not break the head is good.

After the final sharpening and the “stropping” of the edge (stropped on a rotating buffing wheel) it is time to put a handle on the axe head. With the help of a hydraulic press the handle is squeezed into



the axe head together with a wooden wedge. The right angle in relation to the axe head, the alignment and the hang, are tested. The last step is to drive a three legged steel wedge into the wooden wedge.

Finally the axe is carefully checked, the axe head is rubbed with a water repellent and rust preventive oil and the axe is given a leather sheath. Not to be forgotten, The Axe Book is tied to the axe.



The people at Gränsfors Bruks in Sweden are (from left to right): Mikael Sundberg, Rune Andersson, Mattias Mattsson, Lennart Pettersson, Lasse Eriksson, Anna-Karin Pettersson, Jan Elfström, Kjell Åke Sjölund, Per Henrik Bylin, Ove Sjödin, Jonny Mohlén, Paul Norell, Siv Lundholm, Gabriel Brånby, Mats Åke Järnberg, Gunnar Mohlén, Rune Ahlbom. (Yes, it was a dark and cold Monday morning when we took the picture.) Lars Enander, Ulrik Nilsson, Daniel Gräntz, Rose-Marie Jansson, Bert-Ove Andersson, Joakim Eriksson, Fredrika Norlin, Ulrika Stridsberg and Claudia Kowalek were not present.

The family owned Gränsfors Bruks AB has 30 employees in Sweden. In addition to axes, Gränsfors Bruks forge Spring Steel Wrecking Bars, branded “TOVE”, and forestry tools.

A sister company is Gränsfors Bruks, Inc. located in Summerville, South Carolina, USA. Its 25 American employees develop, produce and market unique protective products that allow people working with a chain saw to be safer. Ask for information.





LIMBING A LOG

The axe for limbing is a Scandinavian Forest Axe. The bit of this axe is thin but more curved than the straight bit of, for example, a Carpenter's Axe.

You must have plenty of room in which to swing an axe. Check your clearance and remove any brush or hanging branches that might deflect the swinging axe. Stand on the side of the log opposite the branches you are going to limb so that you always have the log

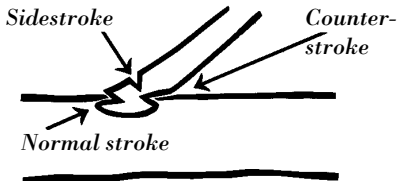

between you and your cuts. If the axe misses a branch, the blade will hit the log rather than your leg. Keep both hands around the handle - the risk of slipping will then diminish. Grasp one hand near the handle knob and the other

hand closer to the axe head at the start of the stroke. Raise the axe, and then let the "head" hand slip down the handle towards the "knob" hand while the axe is swung downward.

Chop the branches from the root end to the top end of the log and chop into the underside of the limb, close to the log and the base of the branch.

Thick branches may sometimes demand so-called "counterstroke" or a

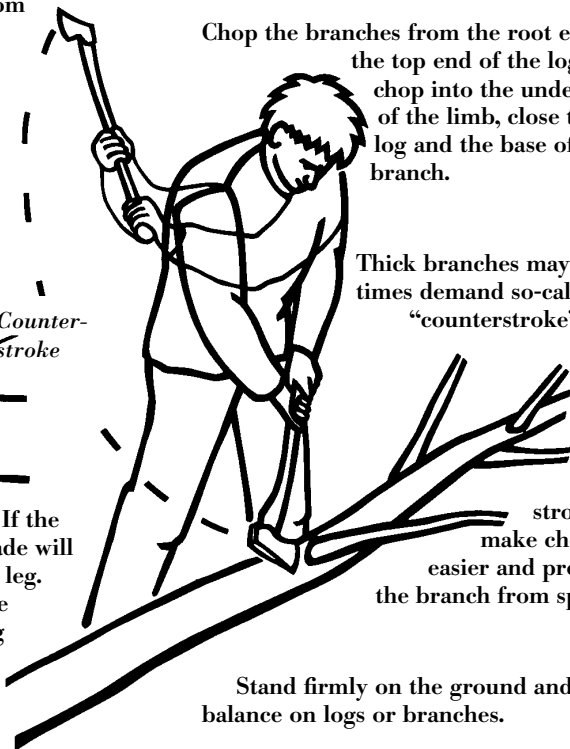

"side-stroke" to make chopping easier and prevent the branch from splitting.

Stand firmly on the ground and never balance on logs or branches.



FIRE WOOD

Fresh wood contains about 45 % water. Before the wood is put into the fire the percentage of water must come down to about 25% or less, which it normally has after a summer's drying.

The bark slows the drying of the wood. Therefore split wood dries more easily than unsplit wood. It also means that split wood does not get moldy or rotten as easily, and of course, is much better to make a fire with. If you think the stick or branch is too thin to split, you can debark a string along it and the wood will dry quicker.

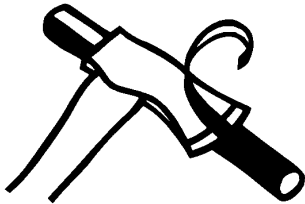

Hardwoods such as oak, maple and hickory have greater energy content than softwoods such as pine, fir and aspen. An old Swedish way, not very common today, is to fell the tree with its leaves on

– especially directly after leafing – and put off the limbing until the leaves have withered. Then much of the water has evaporated through the leaves and the wood dries quickly after splitting. Apart from this old method, winter is regarded as the best time of year for felling. Felling and working with a chain saw will always be a dangerous task. It is important to learn how to use a chain saw and good felling techniques. Always use good protective equipment when felling and cutting with a chain saw.



Saw the log to suitable lengths of wood, “rounds”, with a bow saw or a chain saw. Split the rounds at once – the more it dries the tougher and more difficult it is to split. It is rather easy to split even newly felled thick rounds, yet very difficult to split after a year. Frozen wood is “brittle” and easy to split.



When splitting rounds, you need a Splitting Axe. When splitting big rounds you may need a Splitting Maul and Wedges.

Don't let others come near you while splitting – both the swinging axe and spreading splitwoods constitute risks.

The chopping block should be big, heavy and stable. The kind of wood in the chopping block is less important, but hardwood like oak is most durable.

The block should be quite low, not higher than up to your knee. Stand the round of wood upright on the far side of a big chopping block. If you miss hitting the round, the axe will normally hit the chopping block rather than your leg. Keep both hands firmly around the handle, close to the knob of the handle, with arms straight. That, and a long handle, will give a good “swing”. Keeping your arms straight and adjusting your stance, you will find the right distance to the round. Try to keep the axe handle horizontal when hitting the round. For safety reasons, the hands should never be higher than the axe head when the head is hitting the round. A round is generally easier to split from the top end.

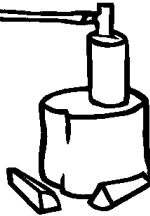
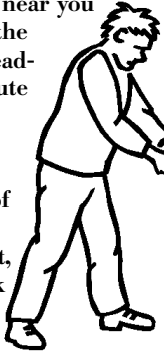

When splitting gnarled cross-grained wood, it is very important that your axe is properly sharpened.

It is common that bigger rounds that do not split from the first chop are split by means of its own weight: the axe's bit is driven into an end of the round, turned and swung with the poll against the chopping block. This technique with a piece of wood wedged on the bit can be dangerous if a large chunk comes off in the swing.



For splitting a small stick in two, press the axe edge against the side of the stick. Grip the stick in one hand and the axe in the other. Raise the stick and the axe together and bring them down hard together on the chopping block.



Try to place the axe head through the center of a round. Also try to place the axe head straight through the limb, if there is one. Big rounds will of course be split in several steps.

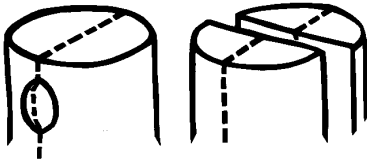

Never push the handle sideways if the axe head is stuck in the wood – the handle may break. Remove it instead with pumping movements of the handle.

When the rounds are really big, gnarled and cross-grained, or have been stored too long and dried which make them hard to split, you might need to use a splitting maul or a splitting maul and wedges. When working with wedges, use two. Wedge number two will help to knock the first wedge out if stuck.

Fasten one wedge on one side. Pound the wedge with the poll of the heavy maul so that you get a crack. Pound the other wedge further in the wood until the crack is widened. Move the first wedge and so on, until the round is split.

Do not use an axe, felling axe, forest axe or a splitting axe, for driving in a steel wedge, or as a wedge, when split-

ting. The poll of these axes is not designed for heavy pounding on a wedge or to be beaten on. That is one of the things which makes an axe different from a maul. The maul's poll is designed and forged to withstand beating on a steel wedge. But constantly check the edges of the poll. Do not let a poll get like a mushroom! Always keep the ground edges of the poll of a maul and a wedge in good shape. Use a file. The ground edges of the poll will reduce, but not eliminate, the risk of flying fragments of the poll.

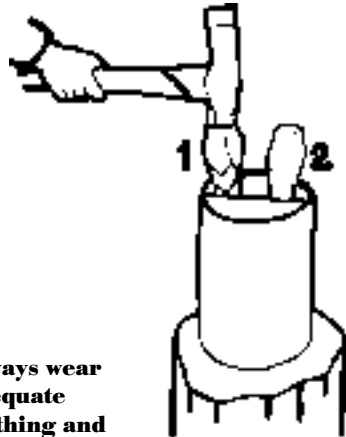

Always wear adequate clothing and protection for your face and eyes when hitting steel against steel – a piece of steel can come off and injure you.



TO DRY AND STORE SPLITWOODS

Firewood must dry thoroughly before use. In the old days they said: “Wood should be split before Easter”; then it can dry during spring and summer, before winter’s wood heating begins.

A few basic rules for your wood yard: Stacked firewood must be chopped or at least debarked in a string to be able to dry. This is particularly important for hardwood with its denser bark.

Place the stack on dry and easily drained ground, preferably in a sunny place.

Put some poles on the ground before stacking so that the wood does not touch the wet ground and air can circulate.

Always stack split wood with the bark side down. Otherwise the bark will function like a lid and prevent moisture from evaporating and the risk for mold will increase.

Stack the split wood a little scattered and it will dry more quickly. In the old days they said that a mouse had to be able to get through.

3. Build a circular wall of large split wood. Put the smaller or uneven wood randomly in the middle.



1. Make a checkered pattern of poles on the ground.



2. Make a loose “floor” of split wood on the poles. Place bark side down.





4. When the stack begins to get high enough you build it up in the middle and round it off to an even pile. Place the uppermost layer of split wood as "tiles" to allow rain water to run off.



A couple of vertical poles, a tree, or a wall can make a stop in one end or both. If you have vertical poles on both ends you may stretch a wire or rope between them, above or in the middle of the stack. Then the stack is more stable and can handle more split wood.

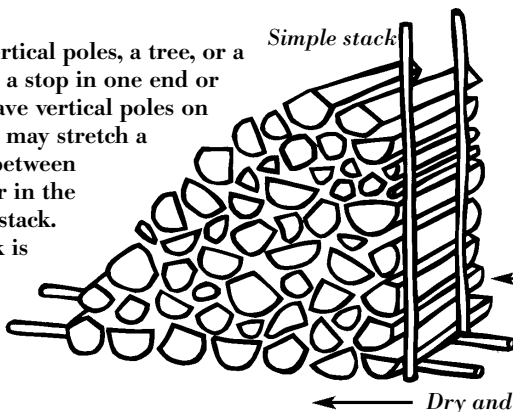

If the stack is built along a wall: Leave an air space between the stack and the wall. Let the stack lean a little inwards to avoid the risk of its collapsing due to shifting during the drying process.

← Bark side down

← Put some poles on the ground

← Dry and well drained ground

Put something, like a tarpaulin, on top of the stack as protection from rain or snow, but don't cover the sides – the stack must allow air to circulate. If using a tarp, tie it down with ropes to poles on the ground. A few heavy logs placed on top of the tarp will prevent it from inflating and being torn during storms.

To avoid going out in the cold and nasty weather to fetch firewood, it is common to stack some dry firewood on the porch or inside the house. But it is important that the wood stacked indoors is completely dry. Otherwise you might have problems with moisture and mold.





TO MAKE A FIRE

In woods and fields

Begin with choosing a suitable place. Appropriate beds for fire are sand, gravel or bare soil. Don't light a fire on flat rocks (they break from the heat and get ugly black marks), peat ground or near dry grass, bushes and trees. You can put stones around the fire you are building.

Use dry sticks and branches for the fire. In a forest you will always find dry sticks to light with – even when it is raining – like on the lower parts of spruce stems.

In old damaged stems and stumps of pine, you sometime find yellowish-red and strong smelling pitchy wood. In dry conditions this resinous wood is one of the best things you can use to light a fire with. Just one split of pitchy wood can light the most impossible fire.

Start lighting with smaller sticks and build up with larger sticks as the fire begins to burn. Extinguish the fire carefully, preferably with water, and restore the ground as much as possible if it is a temporary place for a fire, before you leave.



Teepee Fire Lay (standing splitwood) gives you a quick burning fire, Crisscross Fire Lay (lying splitwoods) give a more prolonged fire.

Pay attention to possible fire prohibitions, especially common during dry springs and summers!

In fireplace and stove

Check that the damper is open. Place the split wood so tightly that the burning wood “warms each other”, but still so scattered that the fire is aired.

In a wood stove you should start with burning some paper in the flue or the soot-door just before you light the fire.

If you are worried that it might smoke, you can see which direction it draws from in the stove by keeping a burning match in the upper part of the opening.



Put in crumpled newspaper or thin small pieces of wood to light with under the wood. If the flame draws out of the stove you should turn off the kitchen fan. If you still have cold

air coming out from the chimney you can open a window in the room just when you light the fire. The air that quickly rushes in then generally goes out through the chimney and gives draft in the right direction.

You can use the same method to “turn” a stove or a fireplace that is smoking.

Don't choke the access of air too much when the fire has burnt up. Check the air access by going out and looking at the smoke: a correctly burning wood fire leaves only carbon dioxide and steam, and therefore you hardly see any smoke at all. If it is very cold the smoke may be white.

All stoves, fireplaces and chimneys need to be cleaned regularly to function well.

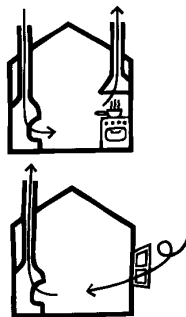

Ashes

Ashes raked out of the stove or the fireplace can cause fire. Therefore ashes ought to be saved a couple of days in a nonflammable vessel to cool off.

Ashes after a wood fire can be saved and spread in the garden (but not in the potato-patch – then the potatoes become shriveled). Wood ashes contain some useful salts, above all potassium bicarbonate, so-called potash, and heightens the pH value in acidified soil. You may mix some wood ashes into your compost as well.

WEARING THE AXE ON YOUR BELT



Most axes from Gränsfors Bruks come with a sheath that let you easily carry the axe on your belt.

Pull the leather sheath strap through the belt.



The axe will sit comfortably and securely.

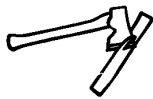

WORKING WITH A CARPENTER'S AXE

The pattern of the head, the weight, the curvature of the bit, the thickness and width of the bit and the beveled face of the edge vary from axe to axe, and make axes perform differently. The Swedish Carving Axe, with a rather thick curved bit and big angle on a wide beveled face, is a good carving tool. But it is not a Carpenter's Axe. The Carpenter's Axe has a thin blade, a straight long cutting edge with low angle of the beveled face. The corners of the bit are pointed. The long straight-edged bit is ideal for guiding by eye. Your eyes can sense position and direction better from a relatively broad, straight axe bit than they can from a narrower, more curved bit. The long straight cutting edge also gives stability when cutting. In a way, the Carpenter's Axe works as a combination of saw, knife and plane. You can do much more with this axe than rough fitting. It is, for example, quite easy to cut a plank's end to the desired angle with a planed surface with the aid of the Carpenter's Axe.

Keep the piece of wood you are working with on a chopping block. Don't use the same block for splitting rounds. The rounds usually carry sand and earth to the chopping block, which makes the edge blunt. Sharpness is very important for

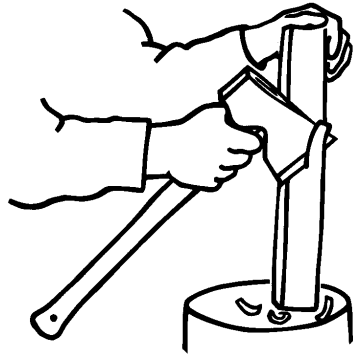

a Carpenter's Axe. Stand a little to the side of the chopping block and be careful to hold the axe at such an angle that the risk of hurting yourself if you slip is reduced.

Keep the working piece on the part of the chopping block that is the outside or away from you so that a slipping cut will hit the chopping block rather than your leg. Grip the handle with one hand in the inward curve of the axe head in order to increase cutting precision.

Let the edge go with a falling movement against the piece of wood, so that the cutting point glides from the lower corner of the bit upwards along the edge. Always cut along fiber direction—otherwise it is easy to split away pieces that were meant to stay.



SOME AXES FROM GRÄNSFORS CATALOGS 1910-1923



Swedish Broad Axe

The blade ground on one side only. Width of Cut from 300 to 400 mm (5 sizes). (Used for squaring logs and structural timbers.)



American Felling Axe, Turpentine Wedge

Weighing from 3 to 7 lb (9 sizes.) (The American Felling Axes have been one of the most used types of axes for forest workers in the northern tempered conifer belt since the middle of the 19th century. Each region had a pattern of its own.)



American Felling Axe, Ohio Wedge

Weighing from 3 to 7 lb (9 sizes). (In Sweden named "Yankee Axe".)

American Shingling Hatchet with hammer-poll

Checked poll and provided with a notch for nail pulling. Width of Cut from 3 1/2 to 4 1/4 inch (3 sizes).



American Claw Hatchet

Width of Cut from 3 1/2 to 4 1/4 inches (3 sizes). (In Sweden named "Packing Axe".)

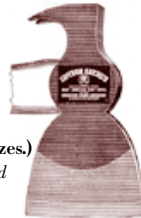

American Broad Hatchet, Carpenter's Hatchet

The blade ground on one side only. Width of Cut from 4 to 8 inches (9 sizes). (Similar to the British Side Hatchet of Kent pattern.)

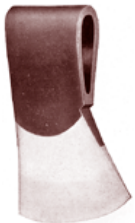

De Tumba, South American Wedge type Axe for felling

Oval Eye. Weighing from 3 to 5 lb (5 sizes). (Most South American Axes had straight-sided blades with no lugs, oval eyes without thickening at the poll. The shape of the blade and eye derives mainly from the Spanish and Portuguese tradition. South American Patterns, "Media Labor" with Oval Eye or Flat Head, "De Tumba" with Flat Head, "Brazil" Narrow or Broad Bit, "Valdivia" with Oval Eye and Viscaina with Oval Eye were also available.)

Russian Hatchet, Siberian Model

Weighing from 2 1/2 to 3 1/2 lb (9 sizes). (Russian Patterns "Arkangelsk" and "Petrograde" were also available.)

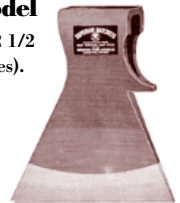



THE USE OF BROAD AXES

The Broad Axe, or the Hewing Axe, is used to shape (hew) logs and timbers of all kinds in the old traditional way, particularly when building log-houses. Broad Axe patterns have varied enormously from region to region and over time.

The bit of the Broad Axe is beveled on one or two sides and the direction of the handle may be straight or angled sideways to protect your knuckles.

*Angled to protect
knuckles*

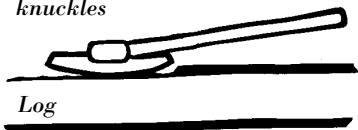

Log



*One side
beveled
bit*

Of course you can shape your logs with a chain saw or electrical equipment but then you will not have as nice a surface as you would using a Broad Axe. We are not going to show in this text how to make a log house, but we will try to describe how to hew a log. Nowadays machines are used to a great extent and only the final work is done by hand. Before hewing by hand begins, the log has to be debarked and sawed on two sides (and often stored 6-12 months or longer to dry to avoid shrinking after the construction work).

The log that is to be shaped is placed on two specially made stands which will create the right working position.

*Wedge, driven from the side,
that locks the log*

Log

*The right height of
the stand is when
you can sit astride
it and have your
feet flat on the
ground.*

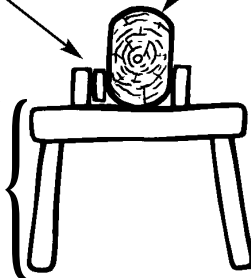

Gränsfors Bruks forges many different Broad Axes and Log Building Tools: Log House Drawknife, Log Dog, Log Scribe, Mortise Axe, Adze, Froe.
Ask for information.

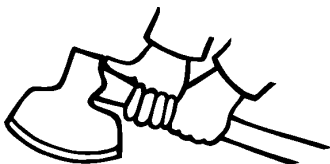

Your hands should be kept quite close to each other. Your right hand should be kept nearest to the head of the Broad Axe. The thumb of your right hand should be kept up on the shoulder of the handle, and not around the handle, to avoid the risk of being hurt.

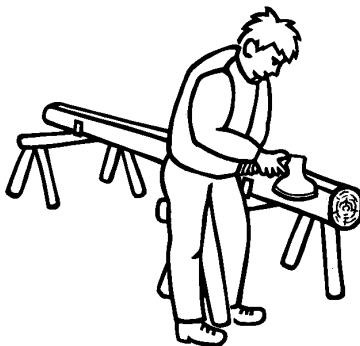

Move backwards while working so that you can always check the surface you have hewed.

The log should be hewed as evenly and water repellantly as possible. Downward cuts and flakes of wood are not allowed to create pockets for rain water. Therefore the log is placed upside-down for hewing, compared to how it will later be placed in the house.

Seasoning checks

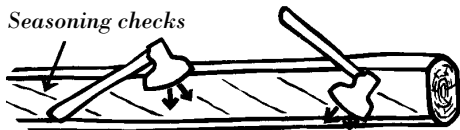

Upper half of log

Lower part of log

Often the log is twisted in the drying process. If the log is twisted with checks going downward from left to right, you have to hew in the direction away from you on the upper half of the log and in a direction towards you on the lower part of the log. If the log is twisted in the opposite way, with checks going upward from left up to right, you have to hew in the opposite direction. In so doing you avoid working in conflict with the structure of the wood.



The seasoning checks are turned inwards if the inside is to be covered with paneling. Otherwise they are turned outwards so that the inside becomes attractive and easy to clean.

AXE THROWING

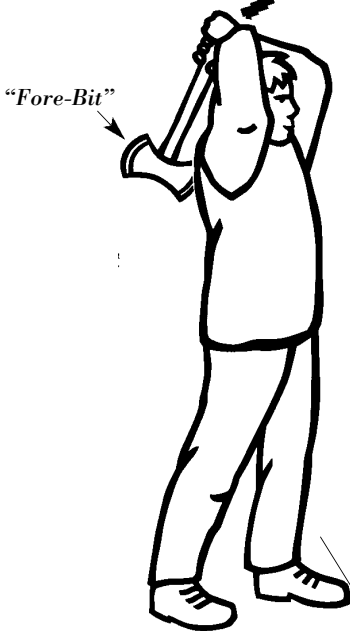

Rules

The straight distance from the “Throwing Line” to the bulls eye on the target should be 20’ (6.1 m).

The thrower may not overstep or cross the “Throwing Line” before the axe has hit or missed the target. This should be checked by a linesman.

The “Fore-Bit” is the bit in the target direction at the moment when the thrower lets the double-bitted axe go. Only the “Fore-Bit” of the the double-bitted axe can score a hit on the target area – a condition is however that the bit sticks in the target.

The “Fore-Bit” only needs to cut the outer edge of a line of the scoring area to win points of that higher scoring area. The “Back-Bit” is not allowed to brush against the target – if so the scoring will be 0 even if the “Fore-Bit” has hit the target at same time.

Best score in minimum of three throws wins.

At competitions, targets for practice should be provided. Practicing throws at targets planned for competition means automatic disqualification. The standards for a **Double-Bitted Competition Axe** and the design for a Competition Target are shown in the drawings.

20' (6

← Throwing Line

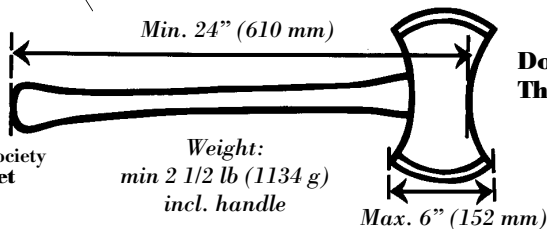

The Swedish Axe Throwing Society
Svenska Yxkastarförbundet
Vålsjö skola Orsta
730 30 Kolsva
www.yxkastarna.com



The Swedish Axe Throwing Society
arranges annual Swedish
Competitions in Axe Throwing.

Organizers and participants: Pay attention to
the security so that none of the participants or
audience will be hurt! Rope off an area large
enough. Enter the area only to throw or check
score.

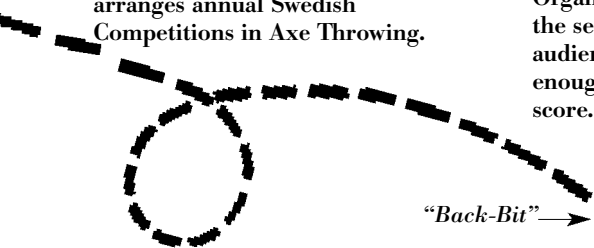

“Back-Bit” →

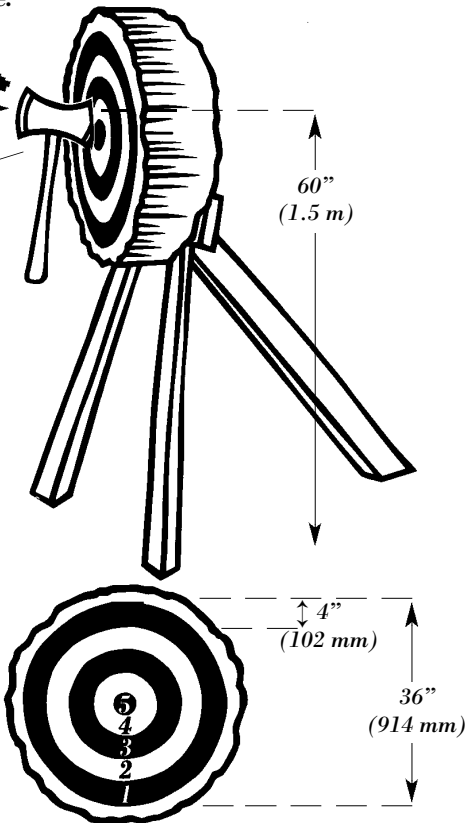

Swedish Champions:

1989 (Men only)	Jan Engman, Leksand
1990 (Men only)	Inge Mörk, Mora
1991 (Men only)	Urpo Salmela, Skövde
1992 (Men)	Tommy Långdahl, Hedemora
1992 (Women)	Sari Sundqvist, Nordanstig
1993 (Men)	Tommy Långdahl, Hedemora
1993 (Women)	Nina Holm, Nordanstig
1994 (Men)	Tommy Långdahl, Hedemora
1994 (Women)	Ulla Sundqvist, Nordanstig
1995 (Men)	Urpo Salmela, Skövde
1995 (Women)	Sari Sundqvist, Nordanstig
1996 (Men)	Anders Lindberg, Tönnånger
1996 (Women)	Karin Eriksson, Östersund
1997 (Men)	Urpo Salmela, Skövde
1997 (Women)	Karin Eriksson, Östersund
1998 (Men)	Henry Olofsson, Strömsund
1998 (Women)	Tina Johansson, Mantorp
1999 (Men)	Roy Bergström, Tönnånger
1999 (Women)	Kristina Gustafsson, Åsbro
2000 (Men)	Roy Bergström, Tönnånger
2000 (Women)	Mona Elofsson, Tönnånger
2001 (Men)	Robert Mårtensson, Strömsund
2001 (Women)	Tina Nordberg, Kolsva
2002 (Men)	Sauli Saari, Kolsva
2002 (Women)	Mona Elofsson, Tönnånger
2003 (Men)	Stefan Persson, Tönnånger
2003 (Women)	Mona Elofsson, Tönnånger
2004 (Men)	Stefan Persson, Tönnånger
2004 (Women)	Tanja Väinölä, Kolsva



CARING FOR YOUR AXE

Axes should be kept in a dry place, but still not so dry or warm that the handle risks shrinking in the axe head. See to it that the bit and the bit sheath are not wet when you put on the sheath. Grease the axe head with oil before the axe is put away for some time. If you don't grease it the axe head may become rusty.

Axe heads are forged in a shape good for cutting. Only the poll of a Splitting Maul is designed for pounding on a steel splitting wedge. Do not use any axe or hatchet, for example a Splitting Axe, for driving in a steel wedge, or as a wedge, when splitting. The poll of an axe is not designed for heavy pounding on a steel wedge or to be pounded on. An axe used for pounding or used as a wedge will be deformed or broken.



Sharpening

The sharpening of an axe is done in several steps, depending on how worn down the axe head is and the type of axe. With a Splitting Maul you may stop at the shaping step. With a Carpenter's Axe or a Forest Axe you have to go through all the steps if you want to have a good cutting tool.

1. Shaping. If terribly damaged, you can use a file to reestablish the original edge bevel, the curve of the edge and bevel face. Do not overheat the edge, which will cause it to lose its temper. Cool often! If the bevel face is straight (Carpenter's Axe, Carving Axe and Broad Axe), the total bevel face should be in contact with the stone or the file.



Axe file

Fine-toothed flat file.

When filing, use a flat fine cut file. Keep the axe head in a vise to allow you to file with two hands. Bear down the file against the sharpening bevel, with some of your fingers on the tip of the file, as you push the file away from yourself with firm and even strokes. Lift the file off the sharpening bevel on the return stroke. Keep free of filings.



2. Grinding. Always keep the original bevel shape! Even a straight bevel face has to be a little convex at the edge; a convex bevel has more strength. If you make the bevel of the bit too straight and thin it will deform or break. You can use



a whetstone (whetstone bench grinder) to grind smaller damage and normal wear and give the edge its basic sharpness.



Whetstone bench grinder with supporting stay

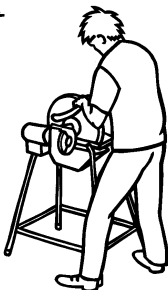

Stand steady with one foot placed beside the grinding machine and support yourself with the axe against a supporting stay on the grinder or with your elbow against your hip. Move the axe slowly back and forth during grinding so that the whole sharpening bevel becomes evenly ground to its original shape. Also grind evenly over the breadth of the grindstone, otherwise it will soon become warped and beveled and difficult to use. Don't leave water in the grinders bucket; it deteriorates the quality of the stone.

You can also use a handstone, usually a round, pocket-size, wet stone with different grits on the two sides. Use the stone with a circular motion, first with the

coarse side then with the fine grit side. Rotate the stone in your hand so it will wear evenly.

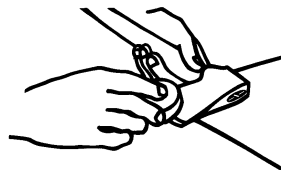

Circular motion

*Gränsfors
Axe grinding Stone
with a
coarse side
and a fine
side made
of sandstone quarried on the island of Gotland, Sweden.*



Can be used with or without water

There are more alternatives: “dry” handstones, and diamonds files. Don't put oil or water on dry stones.



*Axediamond
Has a coarse side and a fine side.*

3. Stropping. After you have finished with the fine grit stone, the bit will usually have a feather-edge, a wispy border of steel attached to the length of the cutting

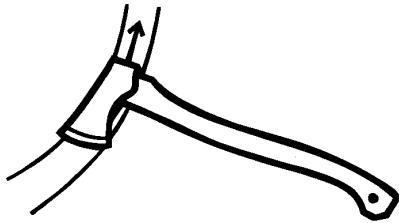

Curved bit

Forest Axe



Straight edge

Carpenter's Axe

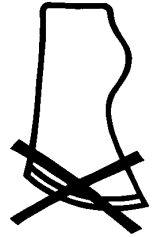

Wrong grind

edge, like a tiny fence. To get rid of the feather-edge and to make the cutting edge more keen you can stroke it against a length of leather, like a belt. The direction of each stroke runs away from the cutting edge.

(At Gränsfors Bruks the cutting edge of the axes are stropped on a rotating buffing wheel made of cloth.)

Always keep the original shape of the bit and the bevel. An axe that is given the wrong shape and bevel face can easily slide and cut you.

The design of the axe head, the curvature of the edge, the bevel face, are adapted to its range of uses: Hardwood demands axes with fairly thick bit, with rounded bevel face; but with softwood cutting, the bit can be thinner; when limbing in frozen wood (frozen wood is hard) the bit must be thicker, and the curvature of the bit more rounded than cutting in non frozen wood; dry wood cutting needs straight bevel face for a nice cut. Not only the thickness of the bit is important for the strength; a rounded curvature of the edge is stronger than a flat curvature.



Hardwood



Softwood



Drywood



Wrong grind



Fitting an axe with a handle

Using an old fashioned wood wedge, supported with a steel wedge, is a safe alternative; you can see if and how the handle is fixed in the axe-eye. If the axe head is loose, you can soak the axe for a few hours in a bucket of water. The wood and the wedge will swell and the handle will be tight for a while. It functions, but we recommend fitting the axe with a new handle, or at least, a new wooden wedge. A loose head is always dangerous, for people and axes! It is important to use handles of high quality. The handle, as well as the wooden wedge, has to be dry. If not, they will dry later and you will have a loose head. Another reason for a loose head is the incorrect use of the axe head as a hammer or a sledge.

The poll of an axe is not designed for heavy pounding. An axe used for pounding or used as a wedge will be deformed or broken and the head will loosen from the handle.

1. Saw off the old handle close to the axe head. (Never burn an old handle from an axe. It will cause the bit to lose its temper.)
2. Drill out the wedge and as much of the wood in the axe head as possible.
3. Punch the rest of the handle backward. Punch from the handle side.

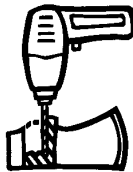

4. Clean inside the eye of the axe.
5. Pound the handle into the head. Let the end of the handle pass an inch on the other side of the head.
6. Test the alignment and the hang. The line of bit must normally lie in the center of the handle knob. (Not for a Broad Axe or a Carpenter's Axe). On a Forest and a Felling Axe the middle of the bit and the handle knob must both touch when laid, with the bit down, on a flat surface. (The alignment can vary depending on the shape of the handle, the handle knob and the model of the axe - for example a Carpenter's Axe or a Carving Axe.)

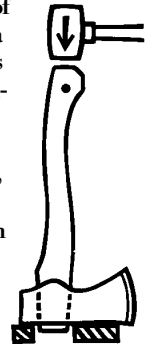
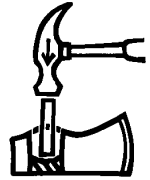

7. Put some glue in the wedge slit and on the wooden wedge. Drive in the wedge.
8. Saw off the excess of the handle and the wedge a little from the head.
9. Fix the wooden wedge with a steel wedge, diagonal to the wooden wedge.





BIBLIOGRAPHY

Robert C. Birkby
The Boy Scout Handbook
Boy Scouts of America 1990

Percy W. Blandford
Country Craft Tools
Gale Research Company 1974

Dudley Cook
**Keeping Warm with an Ax,
A Woodcutter's Manual**
Universe Books 1981

Charles A. Heavrin
The Axe and Man
Memphis 1997

Günter Heine
**Axe Shapes Cornered
The Tools and Trades History Society
Tools & Trades, volume 10**
Kent 1997

Torgny Jansson
Water cobled grinding of edge tools
Tormek, Lindesberg 1993

Henry J. Kauffman
American Axes
Stephen Greene Press 1972

Allan Klenman
Axe Makers of North America
Currie's Forestgraphics Ltd 1990

Leonard Lee
The Complete Guide to Sharpening
The Taunton Press 1995

B. Allan Mackie
Building With Logs
Firefly Books 1997

R. A. Salaman
Dictionary of Woodworking Tools
The Taunton Press 1990

Robert Scharff
Firewood and your chain saw
Reston Publishing Company, 1981

Eric Sloane
A Museum of Early American Tools
Ballantine Books 1973

Wille Sundqvist
Swedish Carving Techniques
The Taunton Press 1990

Bernie Weisgerber & Brian Vachowski
An Ax to Grind, A Practical Ax Manual
USDA Forest Service 1999

Glossary of forest terms
Swedish Centre of Technical Terminology 1969

Gränsfors Bruks AB
Safe Wood Cutters Guide 1992
Ancient Northern European Axes 2002

Sven-Gunnar Håkansson
From Log to Log House
Algrove Publishing 2003

The Axe Book is also available in Swedish, German, French and Japanese.

THE AXE BOOK

is illustrated by Elisabet Berg (except man on p.8) who has taken most of the photos, except the photo at the foot of page 3, Jan Lipka, and at the top of page 17, Magnus & Magnus.

All other product photos are taken by Åke Gunnarsson, VUE. English editor Yvonne Caruso.

Production Eriksson & Gullberg, Stockholm and Illustra Text & Bild, Bergsjö.

We will thank all known and unknown people who have helped us with The Axe Book.

© Gränsfors Bruks AB 2005 ISBN 91-975532-5-5



**GRÄNSFORS BRUKS AB
SWEDEN**

820 70 Bergsjö, Sweden,
Phone + 46 - 6527 1090. Fax + 46 - 6521 4002
yxboken@gransfors.com www.gransfors.com

GRÄNSFORS BRUKS INC.

821 West 5th North Street, P.O. Box 818, Summerville, SC 29483, USA
Phone (843) 875-0240. Fax (843) 821-2285
info@gransfors.com www.gransfors.com

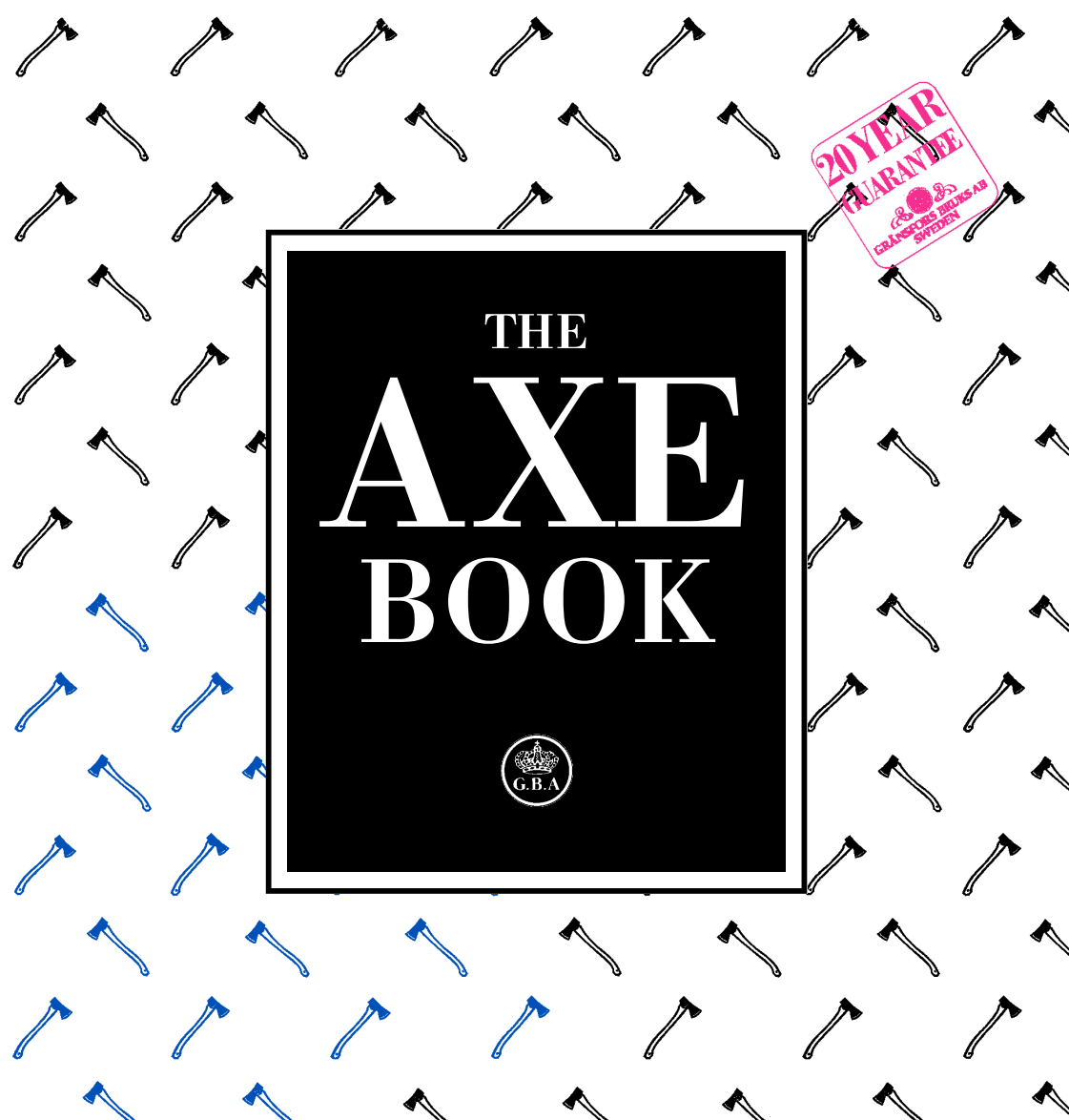

THE
AXE
BOOK



**20 YEAR
GUARANTEE**
G.B.A.
CONFESSORS BELIEVE AS
SWEETEN

Responsibility for the Total

What we take, how and what we make, what we waste, is in fact a question of ethics. We have an unlimited responsibility for the Total. A responsibility which we try to take, but do not always succeed in. One part of this responsibility is the quality of the products and how many years the product will maintain its durability.

To make a high quality product is a way to pay respect and responsibility to the customer and the user of the product. A high quality product, in the hands of those who have learned how to use it and how to look after it, will very likely be more durable. This is good for the owner, the user. But this is good as well as part of a greater whole: *increased durability means that we take less* (decreased consumption of material and energy), *that we need to produce less* (gives us more time to do other things we think are important or enjoyable), *destroy less* (less waste).

**20 YEAR
GUARANTEE**

One of the goals for Gränsfors Bruks is to make high quality durable products. As proof of this goal, and to show that we have a responsibility for the product, Gränsfors Bruks gives a 20 Year Product Guarantee. An “AXE-GUARANTEE-CARD” is included in the AXE-BOOK which comes with every axe. A qualification for the guarantee is that the advice in the AXE-BOOK is followed. Please note for example pages 21, 32–34.

**Gränsfors Bruks has manufactured axes
since 1902 and wrecking bars since 1942.**



AXE MUSEUM

Gränsfors Bruks



Gränsfors Axe Museum has around 2000 axes, mostly from Sweden. The Axe Museum is situated in the eastern part of Sweden, four hours by car from Stockholm to the north, between Hudiksvall and Sundsvall, at Gränsfors Bruks Axe Forge. Open daily. During work days axe forging is shown for the public. Phone Sweden 0652-710 90.

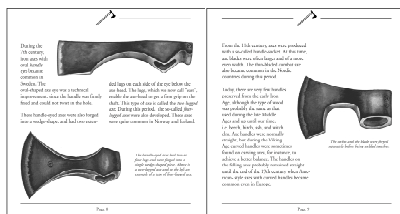
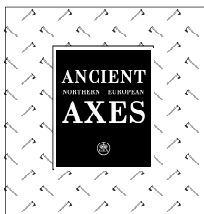

Today Gränsfors Bruks offers a line of what we refer to as “Ancient Axes” Ask for information.